

AVAYA

AWH54/AWH55

WIRELESS OFFICE HEADSET SYSTEM

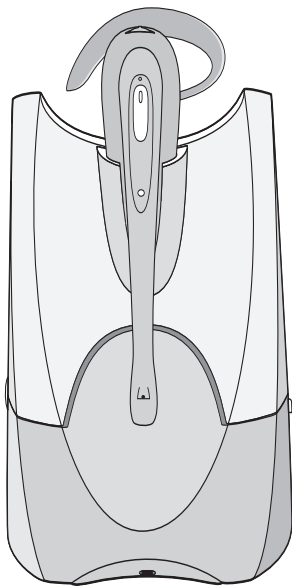

USER GUIDE

OVERVIEW

Thank you for selecting the AWH54/AWH55 Wireless Office Headset System from Avaya. You have made the right choice for comfort and versatility.

This system allows your telephone to use a cordless Avaya headset through an adapting base. It offers hands-free convenience and long-range workspace mobility.

With the use of a hook switch control cord (included with AWH55 only) or an optional handset lifter, the user can remotely receive the telephone's ring alert and can answer the call by simply pushing the talk button on the headset.

CONTENTS

Overview	2	Place and Recieve Calls	15
Important Safety Information	3	Features	16
Components of Base	4	Recharge Headset	17
Components of Headset	5	Replace Battery	17
AWH55 Setup 1	6	Troubleshooting	18
AWH55 Setup 2	7	Subscription	21
AWH54 Setup 3	8	System Reset	22
Charging and Positioning		Maintenance	22
Headset	9	Parts and Accessories	23
Wearing Options	10	FCC Information	25
Test Call	11	Industry Canada	26
Compatibility Adjustments	11	AVAYA Support	27
Listen Volume	12		
Speak Volume and Mute	13		
IntelliStand™	14		
Talk Mode.....	14		

IMPORTANT SAFETY INFORMATION

General

 When using your telephone equipment these basic safety precautions and warnings should be followed to reduce the risk of fire, electric shock, and injury to persons.

- Read and follow all instructions and warnings and instructions prior to using the product. The symbol  identifies and alerts the user to the presence of important operating, safety, and service instructions.
- This product contains gold-plated nickel, phosphor bronze and copper. If you experience a skin irritation, discontinue use and contact Avaya.
- This product is intended to be powered by a Listed Class 2 Direct Plug-In Power Unit rated 9VDC at 800mA, Part No. 64401-02, rated at an input voltage of 120 VAC, 60Hz and an output voltage of 9 VDC at 800mA.
- This product requires AC power in order to operate. During a power outage, have another telephone available that is powered only by the telephone line.

Warning

- Do not locate this product near water, for example, near a bathtub, or sink, in a wet basement, or near a swimming pool.
- This product should never be placed near or over a radiator or heat register. It should not be placed in a built-in installation unless proper ventilation is provided.
- Do not allow anything to rest on the power cord. Do not locate this product where persons walking on it will damage the cord.
- Do not overload outlets and extension cords as this can result in risk of fire or electric shock.
- Never disassemble or push objects of any kind into the product since this may short out parts which could result in a fire or electric shock. Never spill liquid of any kind on the product.
- Use caution when installing or modifying telephone lines.
- Avoid using telephone equipment during an electrical storm.
- Keep all product cords and cables away from operating machinery.
- Do not use this equipment to report a gas leak while you are in the vicinity of a gas leak.
- Never allow children to play with the headset/adaptor—small parts may be a choking hazard.
- Unplug this product from the wall outlet before cleaning. Do not use liquid cleaners or aerosol cleaners. Use a damp cloth for cleaning.

Battery Safety

-  To reduce the risk of fire or injury to persons, read and follow these instructions.
- Use only the battery pack supplied with this product, part number 64399-02.
- Do not dispose of battery pack in a fire. The cells may explode. Check with local codes for disposal instructions.
- Do not open or mutilate battery pack. Released electrolyte is corrosive and may cause damage to eyes or skin and may be toxic if swallowed.
- Exercise care in handling the battery pack in order not to short the battery contacts with conducting materials such as rings, bracelets, and keys. The battery or conductor may over-heat and cause burns.
- Charge the battery pack in accordance with instructions supplied with this unit.
- Observe proper orientation between battery pack and charger contacts.
- Batteries can be swallowed by children and are dangerous if swallowed. Always store and dispose of batteries where children can't reach them.

SAVE THESE INSTRUCTIONS

COMPONENTS OF BASE

Base & Charging Unit

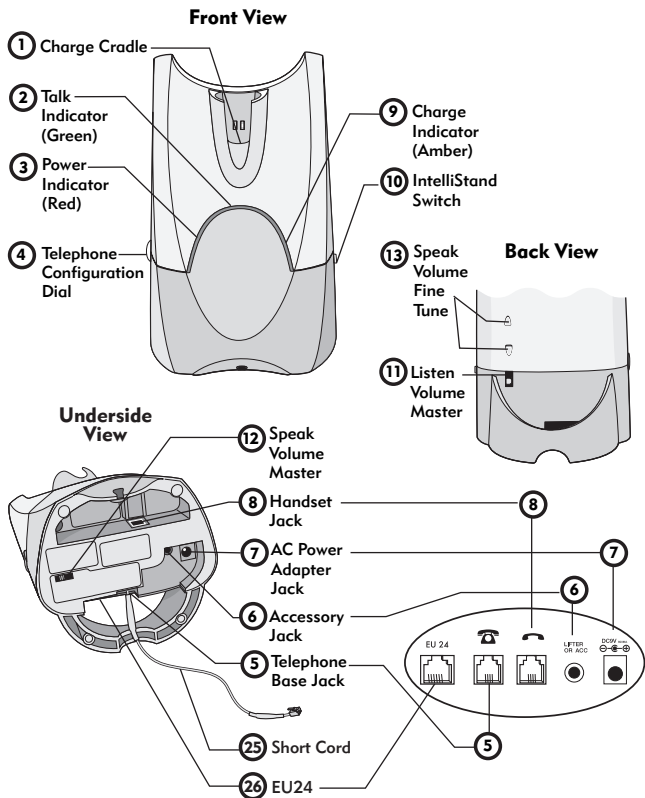

COMPONENTS OF HEADSET

Cordless Headset

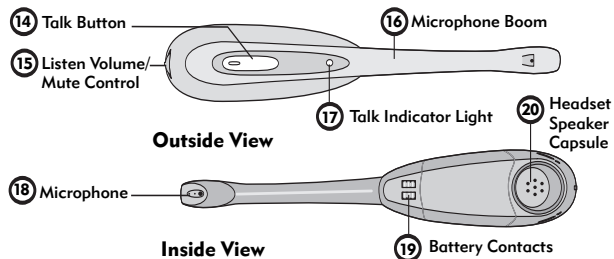

WEARING OPTIONS

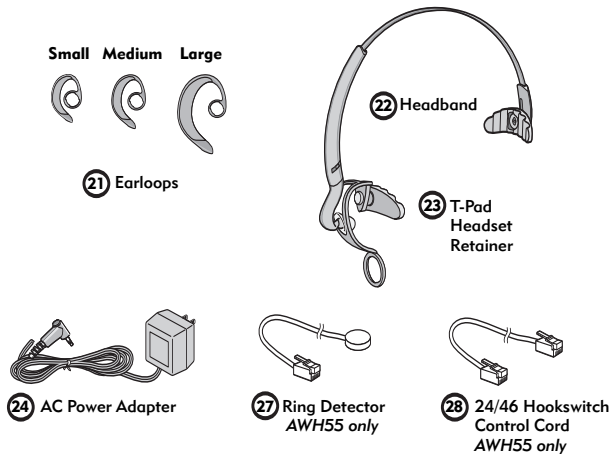

AWH55 SETUP 1

with AVAYA 2420, 4610SW, 4620,
4620SW, 4621SW, 4622SW, 4625SW, 4630SW
5420, 5610 and 5620 Telephones

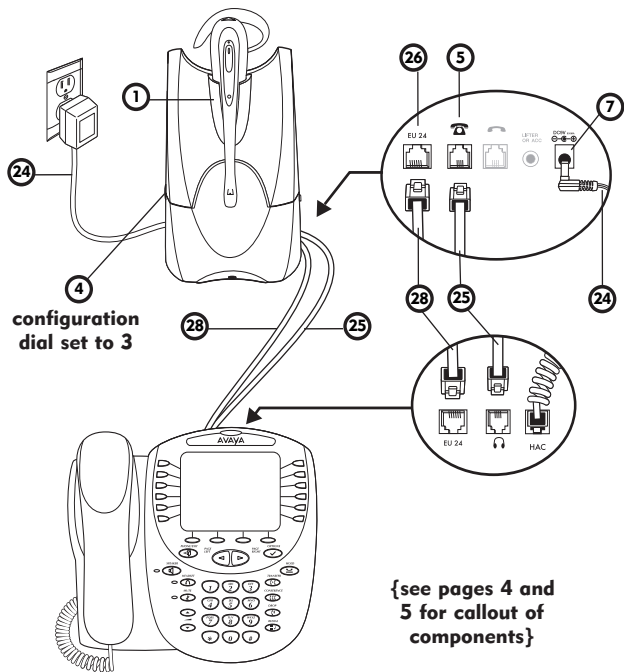

AWH55 SETUP 2

with AVAYA 2410, 5410, 6416 D+M and 6424 D+M Telephones

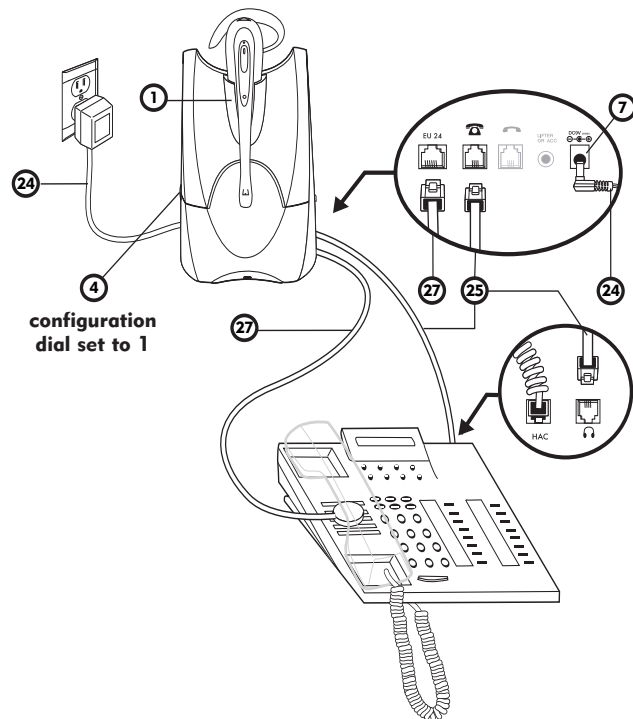

AWH54 SETUP 3

with other AVAYA Telephones

Caution: It is important for correct and safe operation that the base cord is installed into the proper jack of your telephone. Follow these instructions carefully, especially if your telephone has two jacks where the handset was attached. Be sure to note or mark which jack was used for the handset.

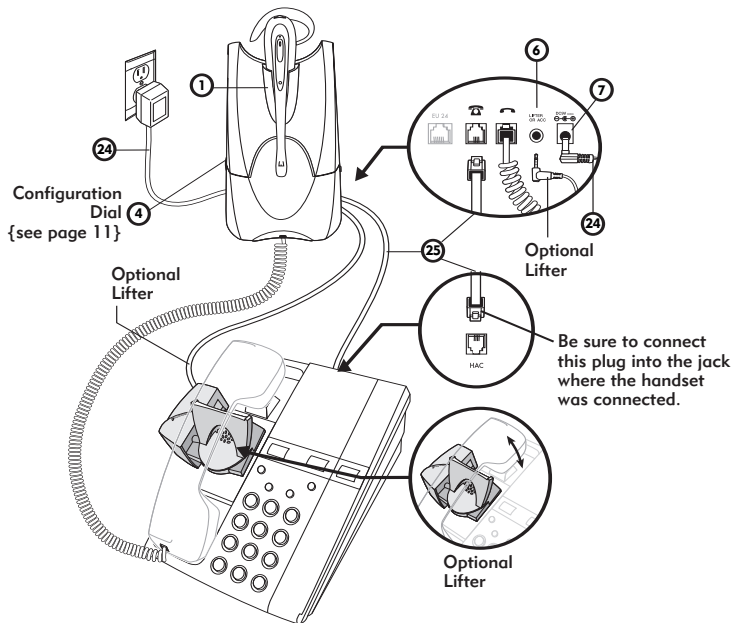

CHARGE YOUR HEADSET

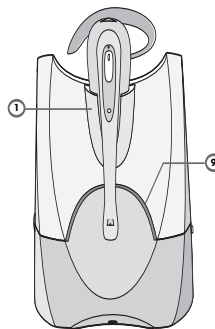

Dock the headset into the charge cradle (1). The amber charge indicator (9) will flash during charge.

If charge indicator does not go on, reposition headset in the cradle.

The charge indicator will go steady after headset is fully charged and ready for use (approximately 3 hours).

POSITIONING

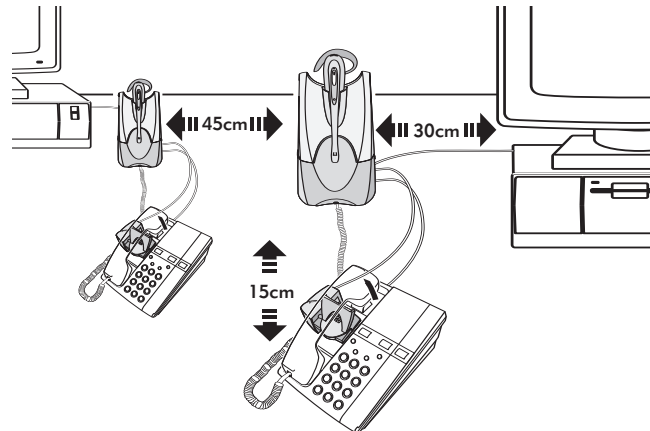

SELECT YOUR HEADSET WEARING OPTION

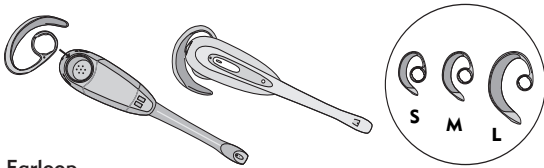

Earloop

Headset with Tri-Pod



Optional Uniband Headset



Neckband

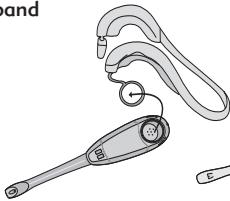

Optional

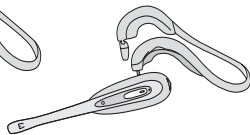

MAKE A TEST CALL

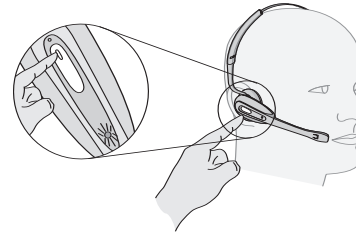

To place a test call press the talk button on the headset.

Important: If your telephone has a receive volume control ensure it is set no higher than mid-range—too high a setting could cause audio problems.

COMPATIBILITY WITH YOUR TELEPHONE

It is very important that the configuration dial (4) is positioned correctly. Audio problems may be experienced if this is incorrectly set. If you cannot hear a dial tone through your headset, turn the configuration dial until you obtain it. Then dial a co-worker and whilst speaking, turn the configuration dial through the 4 positions. Select the position that provides the best sound quality for both you and your co-worker. During this call you should also adjust the Listen and Speak Volume and Listen Tone as described next. Once set, the configuration dial will not require any further adjustment.

Continue configuration setup by making a test call to a friend or associate using the key pad on your telephone.

Adjust your telephone configuration dial on the base to position 3 for the following telephones: 2420, 4610SW, 4620, 4620SW, 4621SW, 4622SW, 4625SW, 4630SW, 5420, 5610 and 5620. Adjust the configuration dial to position 1 for the following telephones: 2410, 5410, 6416 D+M and 6424 D+M. For other telephones, adjust the configuration dial to any position where you hear a tone.

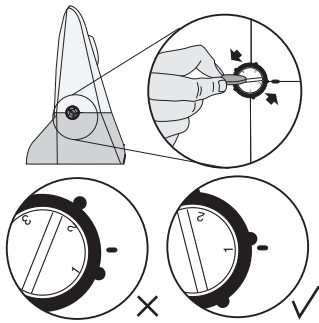

If they cannot hear you at all, try changing your telephone configuration dial on the base to another one of its 4 positions until you hear them and they hear you. Volume adjustments can be made separately as described in the next step.

LISTEN VOLUME

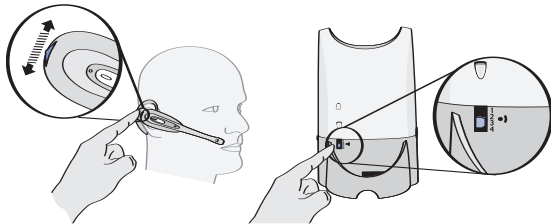

A: Adjust the Listen Volume (how others sound to you) to a comfortable level.

B: If you cannot find a comfortable Listen level, try different settings on the Listen Volume Master Switch until a satisfactory sound level is experienced.

Important: Listen Volume set too high can cause audio problems. Please refer to the Troubleshooting section of this guide for more information.

SPEAK VOLUME

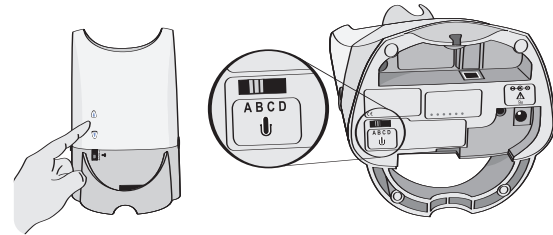

A: Adjust the Speak Volume (how you sound to others) until the level is comfortable for your co-worker.

B: If you cannot find a comfortable Speak level, try different settings on the Speak Volume Master Switch (A-D) until a satisfactory sound level is experienced.

Important: Speak Volume set too high can cause audio quality problems. Please refer to the Troubleshooting section of this guide for more information.

MUTE BUTTON

To mute a call, press the mute button once (three beeps will sound). To take the call off mute, press the button again.

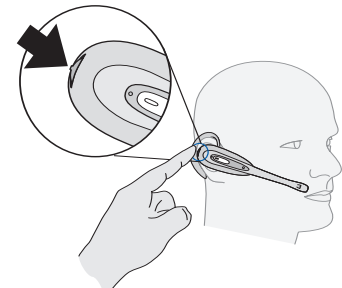

ENABLE/DISABLE INTELLISTAND™

When the AWH54/AWH55 Wireless Headset System is used in conjunction with a Hookswitch Control Cord or an AVAYA Telephone Handset Lifter, you can enable the IntelliStand feature.

The IntelliStand senses when the headset has been removed or placed in the AWH54/AWH55 base unit, automatically activating the lifter and enabling headset/handset mode to answer or end a call.

The IntelliStand feature is disabled (off) when the IntelliStand switch is in position I (up), or enabled (on) when the switch is in position II (down).

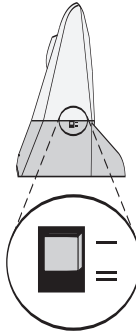

USE THE HEADSET/HANDSET MODE

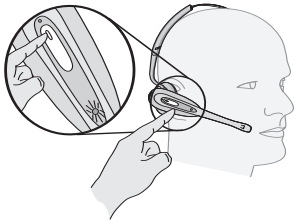

Pressing the talk button (14) on the headset selects headset mode. The talk indicator (2) on the base unit will illuminate steady green and the talk indicator light on the headset will also flash when in headset mode. Both of the indicators are off when in handset mode.

TIP: By selecting handset mode after completing your call, you will conserve the headset battery power and extend the remaining available talk time. You can achieve this by pressing the talk button immediately on conclusion of the call.

PLACE A CALL USING YOUR HEADSET

To place a call using the headset, the system must be in headset mode and dial in the normal way. You will then be able to talk through your headset. When the call is complete, return the AWH54/AWH55 to the handset mode.

RECEIVE A CALL USING YOUR HEADSET

When your telephone rings, take your AWH54/AWH55 Wireless Headset System to the headset mode. You will then be able to talk through your headset.

When the call is complete, return the system to the handset mode.

PLACE AND RECEIVE A CALL USING HANDSET

In handset mode the telephone can be used to make and receive calls in the normal way. Ensure that your AWH54/AWH55 Wireless Headset System is in handset mode.

FEATURES

Out of Range Warning

As you walk away from the base unit you will eventually reach the system operating range limit. When in headset mode a warning alert of two beeps will sound in the headset shortly before you meet the range limit.

On hearing this alert you should walk closer to the base unit to ensure call quality is maintained.

If you remain out of range for more than 15 minutes the system will drop the call permanently. If using a Handset Lifter the handset will be replaced and the call terminated.

Low Battery Warning

When the headset battery is running low (approximately 5 minutes talk time remaining), an audible warning will be heard through the headset as a single beep repeating every 10 seconds. Soon after hearing this warning, you should recharge the headset.

Recharge the Headset

To recharge the headset, place it into the charge cradle in the base unit. During charging, the charge indicator on the base unit will flash amber.

When the headset is fully charged, the charge indicator on the base unit will stop flashing and remain illuminated.

A completely depleted headset requires a minimum charge time of 1 hour before use, and 3 hours to fully charge.

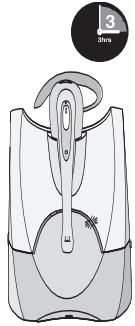

Replace the Headset Battery

Should it be necessary to replace the headset battery at anytime please refer to the diagrams below.

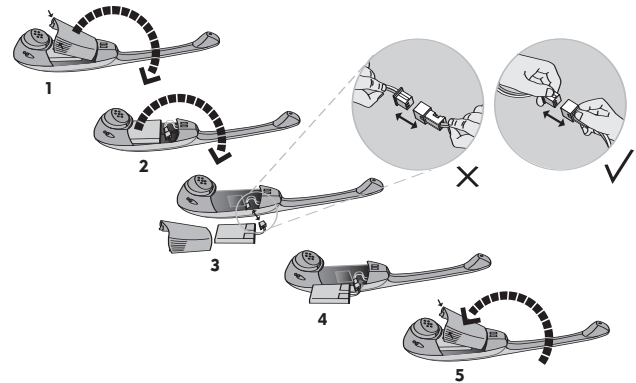

TROUBLESHOOTING

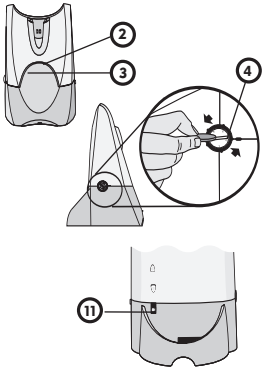
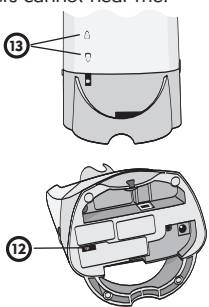
SYMPTOM	SUGGESTION
<p>I cannot hear caller/dial tone.</p> 	<ul style="list-style-type: none"> • Check that all cords and jacks are connected correctly. • Check that the base has power (power indicator (3) is red) and the headset battery is fully charged. • Try other telephone configuration dial (4) settings on the base unit. Ensure the selected number is directly in line with the horizontal position indicator. • Ensure you are in headset mode. Press the talk button to select correct mode. <p>The talk indicator (2) light on the base is on (green).</p> <ul style="list-style-type: none"> • Select another listen volume master (11) setting on the base.
<p>Callers cannot hear me.</p> 	<ul style="list-style-type: none"> • Try other telephone configuration dial (4) settings on the base unit. Ensure the selected number is directly in line with the horizontal position indicator. • Increase the speak volume fine tune (12) on the base unit. <p>If the volume is still too low, increase the talk volume master setting (12) on the bottom of the base unit.</p> <ul style="list-style-type: none"> • Check that the mute function is off.

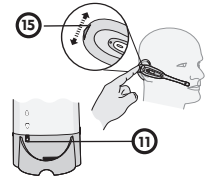
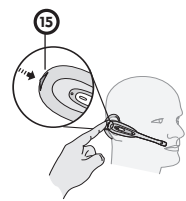
SYMPTOM	SUGGESTION
<p>Receive sounds distorted. away</p> 	<ul style="list-style-type: none"> • Move the AWH54/AWH55 base unit further from telephone or computer. • If your telephone has a receive volume control, lower your telephone volume until the distortion disappears. • Lower the listen volume (15) control on the headset. If the distortion persists, lower the listen volume master (11) setting on the back of base. • Perform system reset. See page 22.
<p>People I talk to can hear a buzz in the background.</p>	<ul style="list-style-type: none"> • Your phone may be sensitive to 900 MHz. Move the AWH55/AWH55 base further away from your phone. • If the AC Adapter is plugged into a power strip, try plugging it into the wall directly. • Call the AVAYA Headset Support Line (page 27) for a RF filter.
<p>I can hear beeps in the headset.</p> 	<ul style="list-style-type: none"> • One beep every 10 seconds is caused by a low battery warning. Recharge battery by returning it to the base charge cradle for one to three hours until charge light stays lit or quits blinking. • Two beeps is an out of range warning. Move closer to the base. • Three rapid beeps every 15 seconds indicates your mute is on. Press the mute control (15) dial once to turn mute off. • When an optional lifter is connected, three repetitive beeps indicate a call is coming into the headset. Press the talk button on the headset to answer the call.

SYMPTOM	SUGGESTION
I can hear too much echo or sidetone.	<ul style="list-style-type: none"> • Lower the speak volume fine tune (13) on the base unit. • If the volume is still too high, lower the speak volume master (12) setting.
My handset lifter operates every time I remove or replace my headset in the base unit.	<ul style="list-style-type: none"> • Disable the IntelliStand function by moving the IntelliStand switch (10) to position I (off).
Battery talk time performance is significantly degraded even after a full recharge.	<ul style="list-style-type: none"> • Replace battery with a new battery pack. Refer to the diagrams on page 17.
Headset is uncomfortable when worn in over-the-ear mode.	<ul style="list-style-type: none"> • Try changing earloop sizes. Experiment to find the best fit.
Suddenly the call is dropped. (Talk indicator on the headset and base will not be illuminated.)	<ul style="list-style-type: none"> • Try to reset the system. See page 22. If this does not work, try the subscription procedure on page 21.
I hear static that does not allow me to communicate.	<ul style="list-style-type: none"> • Try to re-establish a link by pressing the headset talk button. If that does not work, try resetting the base unit. See Step 4 of System Reset on page 22. Last, try the whole System Reset procedure on page 22.

SUBSCRIPTION

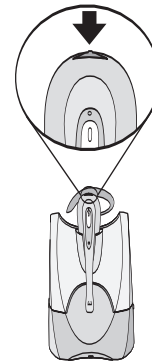
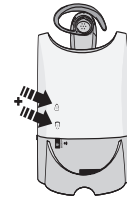

The headset and base unit are supplied subscribed to each other. However, if you wish to use a replacement headset with the base unit, then the units must be re-subscribed as follows:

1. Return the headset to the headset charge cradle.
2. Press and hold both the talk volume fine tune buttons on the base unit for a minimum of 5 seconds. The power indicator (3) will then flash (red).
3. Press and hold the headset mute control button for a minimum of 5 seconds. The talk indicator light (17) on the headset will then illuminate (green).

Successful re-subscription is indicated when the power indicator is fully illuminated and the talk indicator light is off.

4. To complete the process, reset the base unit by disconnecting the AC power adapter (24) from the AC power adapter jack (7) for 5 seconds, then reconnect.
5. If re-subscription fails within 2 minutes the headset will return to the un-subscribed state. Try the re-subscription process again or call Technical Support (page 27).

SYSTEM RESET

To recover from some fault conditions (refer to the Troubleshooting Section) you may need to perform a system reset.

To perform the system reset follow this procedure:

1. Press both the talk button (14) and the mute control (15) button on the headset for 5 seconds.
2. When the talk indicator light (17) on the headset blinks, release both buttons.
3. Press the talk button again.
4. Next reset the base unit by disconnecting the AC power adapter (24) from the AC power adapter jack (7) for 5 seconds, then reconnect.

The system reset operation is complete.

MAINTENANCE

1. Unplug the unit from the telephone and the AC adapter from the power source before cleaning.
2. Clean the equipment with a damp (not wet) cloth.
3. Do not use solvents or other cleaning agents.

PARTS & ACCESSORIES

DESCRIPTION

Telephone Handset Lifter

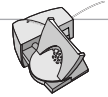

On-line Indicator



Battery



Battery Door



AC Adapter

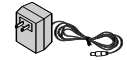

24/46 Hookswitch Control Cord



Ring Detector



Short Cord



AWH54/AWH55 Headset



PARTS & ACCESSORIES

DESCRIPTION

Earloops—pack of 3



Uniband Headset



Replacement Cushions Foam (2)



Replacement Cushions Leatherette (2)



Behind-the-Head Neckband with Adapter



Headset with Tripod



Tripod



For information on spare parts and accessories, call the AVAYA Headset Support Line (see page 27).

FCC REGISTRATION INFORMATION

FCC Requirements—Part 15

This device complies with Part 15 of the FCC Rules. Operation is subject to the following two conditions:

1. This device may not cause harmful interference, and
2. This device must accept any interference received, including interference that may cause undesired operation.

This equipment has been tested and found to comply with the limits for a Class B digital device, pursuant to Part 15 of the FCC Rules. These limits are designed to provide reasonable protection against harmful interference in a residential installation. This equipment generates, uses, and can radiate radio frequency energy and, if not installed and used in accordance with the instructions, may cause harmful interference to radio communications.

However, there is no guarantee that interference will not occur in a particular installation. If this equipment does cause harmful interference to radio or television reception which can be determined by turning the radio or television off and on, the user is encouraged to try to correct interference by one or more of the following measures:

1. Reorient or relocate the receiving antenna.
2. Increase the separation between the equipment and receiver.
3. Connect the equipment into an outlet on another circuit.
4. Consult the dealer or an experienced radio/TV technician for help.

RF Exposure Information

This device and its antenna must not be co-located or operated in conjunction with any other antenna or transmitter. To comply with FCC RF exposure requirements, only use supplied antenna. Any unauthorized modification to the antenna or device could void the user's authority to operate this device.

FCC Requirements—Part 68

This equipment complies with Part 68 of the FCC rules and the requirements adopted by ACTA. On the exterior of this equipment is a label that contains a product identifier in the format US:AAAEQ##TXXXX. If requested, this information must be provided to your telephone company.

A plug and jack used to connect this equipment to the premises wiring and telephone network must comply with the applicable FCC Part 68 rules and requirements adopted by ACTA. A compliant telephone cord and modular plug is provided with this product. It is designed to be connected to a compatible jack that is also compliant. See installation instructions for details.

The REN is useful to determine the quantity of devices you may connect to your telephone line. Excessive RENs on a telephone line may result in the devices not ringing in response to an incoming call. In most, but not all areas, the sum of the RENs should not exceed five (5.0). To be certain of the number of devices you may connect to your line, as determined by the REN, contact your local telephone company. For product approved after July 23, 2001, the REN for this product is part of the product identifier that has the format

US:AAAEQ##TXXXX. The digits represented by ### are the REN without the decimal point. (For example, 03 represents a REN of 0.3.) For earlier producers, the REN is separately shown on the label.

If this telephone equipment causes harm to the telephone network, the telephone company will notify you in advance that temporary discontinuance of service may be required. But if advance notice isn't practical, the telephone company will notify the customer as soon as possible. Also, you will be advised of your right to file a complaint with the FCC if you believe it is necessary.

The telephone company may make changes in its facilities, equipment, operations, or procedures that could affect the proper functioning of your equipment. If they do, you will be notified in advance in order for you to make necessary modifications to maintain uninterrupted service.

If trouble is experienced with this unit, for repair or warranty information, please contact customer service at (800) 544-4660. If the equipment is causing harm to the network, the telephone company may request that you disconnect the equipment until the problem is resolved.

DO NOT DISASSEMBLE THIS EQUIPMENT: it does not contain any user serviceable components.

We recommend the installation of an AC surge arrester in the AC outlet to which this equipment is connected. Telephone companies report that electrical surges, typically lighting transients, are very destructive to customer terminal equipment connected to AC power sources.

INDUSTRY CANADA NOTICE

Notice: This equipment meets the applicable Industry Canada Terminal Equipment Technical Specifications. This is confirmed by the registration number. The abbreviation, IC, before the registration number signifies that registration was performed based on a Declaration of Conformity indicating that Industry Canada technical specifications were met. It does not imply that Industry Canada approved the equipment. The Industry Canada registration number is located in the bottom of the unit. Before installing this equipment, users should ensure that it is permissible to be connected to the facilities of the local telecommunications company. The equipment must also be installed using an acceptable method of connection. The customer should be aware that compliance with the above conditions may not prevent degradation of service in some situations. Repairs to certified equipment should be coordinated by a representative designated by the supplier. Any repairs or alterations made by user to this equipment, or equipment malfunctions, may give the telecommunications company cause to request the user disconnect the equipment. Users should ensure for their own protection that the electrical ground connections of the power utility, telephone lines and internal metallic water pipe system, if present, are connected together. This precaution may be particularly important in rural areas.

Caution: Users should not attempt to make such connection themselves, but should contact the appropriate electric inspection authority, or electrician, as appropriate.

RSS 210

This digital apparatus does not exceed the Class B limit for radio noise emissions from digital apparatus set out in the Radio Interference Regulations of Industry Canada. Operation is subject to the following two conditions:

1) this device may not cause interference, and 2) this device must accept any interference, including interference that may cause undesired operation of the device.

Accessing the Avaya Unified Communication Center (UCC) from the AWH54/AWH55

1. Connect the AWH54/AWH55 to the Avaya telephone. Follow the instructions in this user's guide.
2. Ask your switch administrator to configure your telephone for ringdown to the UCC in your telephone first call appearance.*

* Notes for switch administrators on configuring ringdown for your AVAYA telephones:

- Some phones allow for direct ringdown configuration, i.e.: 2500
- Other phones do not allow for direct ringdown configurations, i.e.: 64XX. In order to configure the ringdown in these phones the administrator needs to:
 - Create a phantom extension setup as a 2500 type (No real port has to be assigned).
 - Create a ring down to the UCC for the phantom extension.
 - Bridge the phantom extension to the telephone call appearance 1 (configure it as an "abrdg-appr" and setup the "Auto Select Any Idle Appearance" to Yes).

**The Avaya Headset Support Line is ready to assist you!
Dial (800) 544-4779 Monday through Friday, 5A.M. to 5P.M.
Pacific Time. For accessibility information also call the
Avaya Headset Support Line.**

AVAYA

www.avaya.com

© 2005 Plantronics, Inc. All rights reserved. IntelliStand is a registered trademark of Plantronics, Inc.
US patents 5,210,791; 6,735,453; D492,667 and D496,029; EM 69109; Patents Pending

Printed in China 63915-03 (5-05)